

# Data Sheet



Article number: 021408980022

Description: Sealing Clamp S 22 W1

## Measures

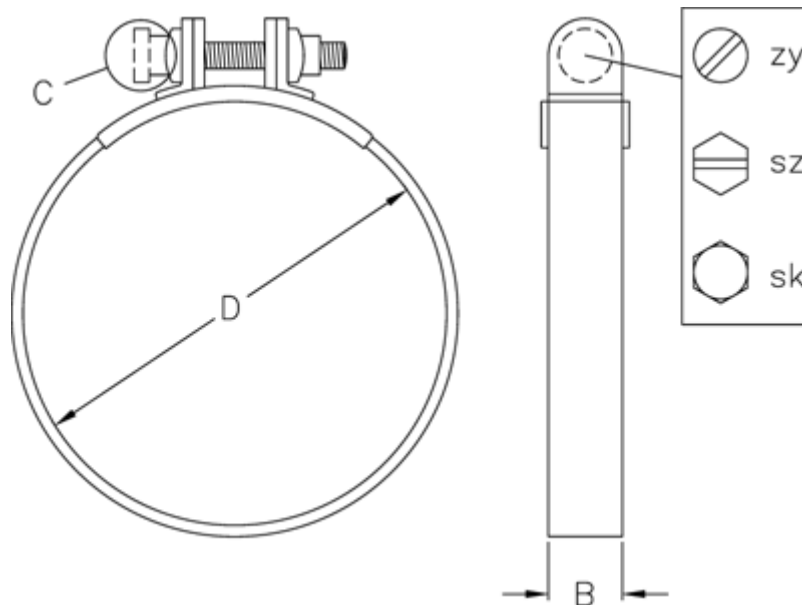

C (screw type) = SZ

Diameter D = 22

Width B = 15